

Factory & HQ

Zona Industrial de Canas de Senhorim - EN 234, 3525-040 Canas de Senhorim - Portugal

+351 232 673 530 ✉ sales@staffordtowercranes.com

🌐 staffordtowercranes.com



Empresa certificada no âmbito da Conceção, Fabrico e Serviço Pós-venda de Gruas Soima e componentes

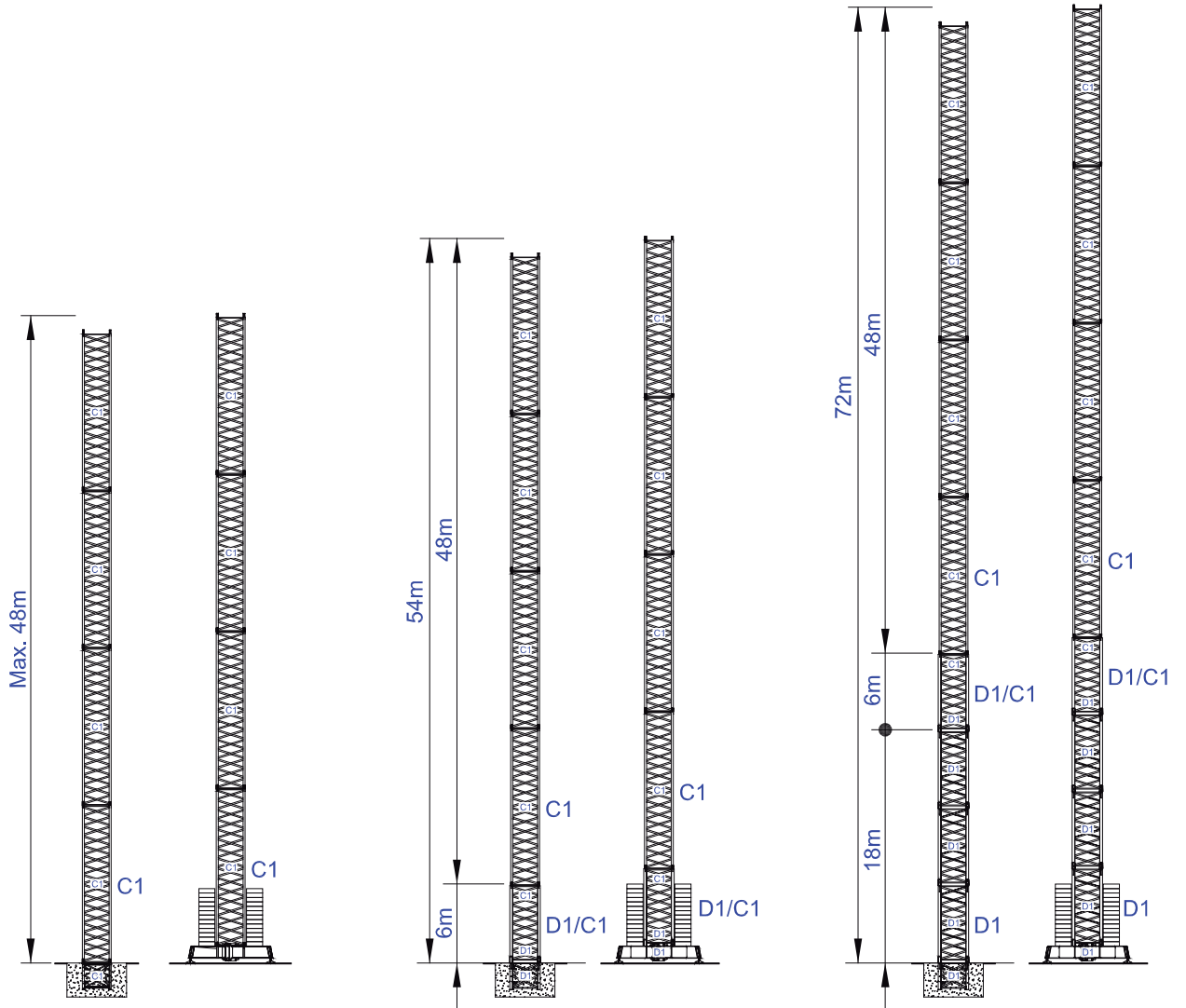

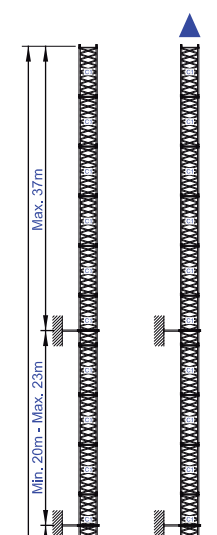
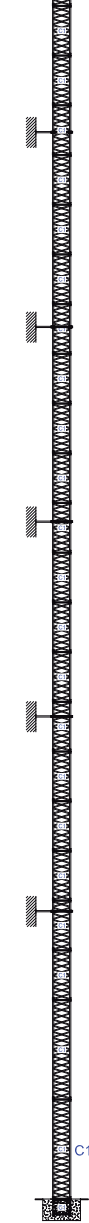
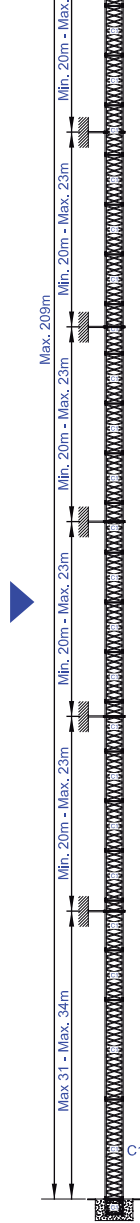
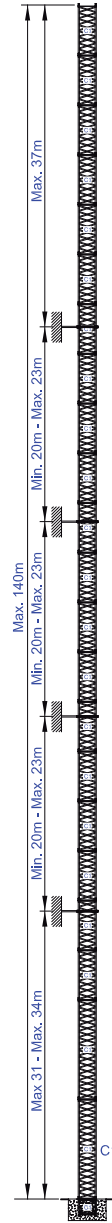
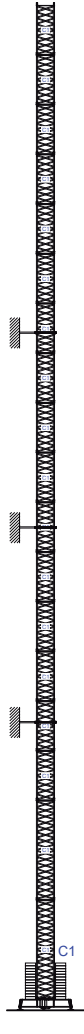
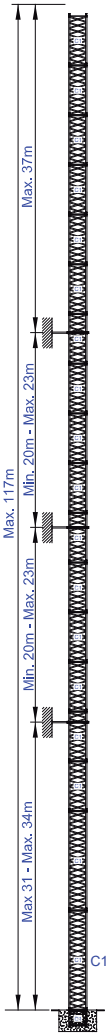
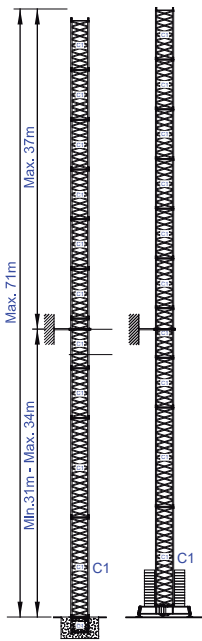
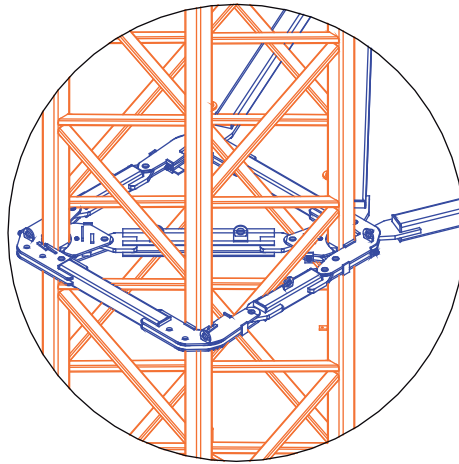
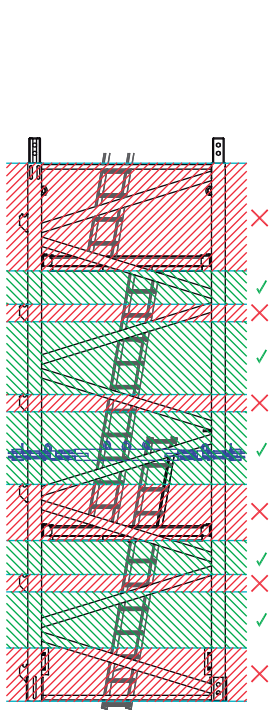

More options
 

 C25

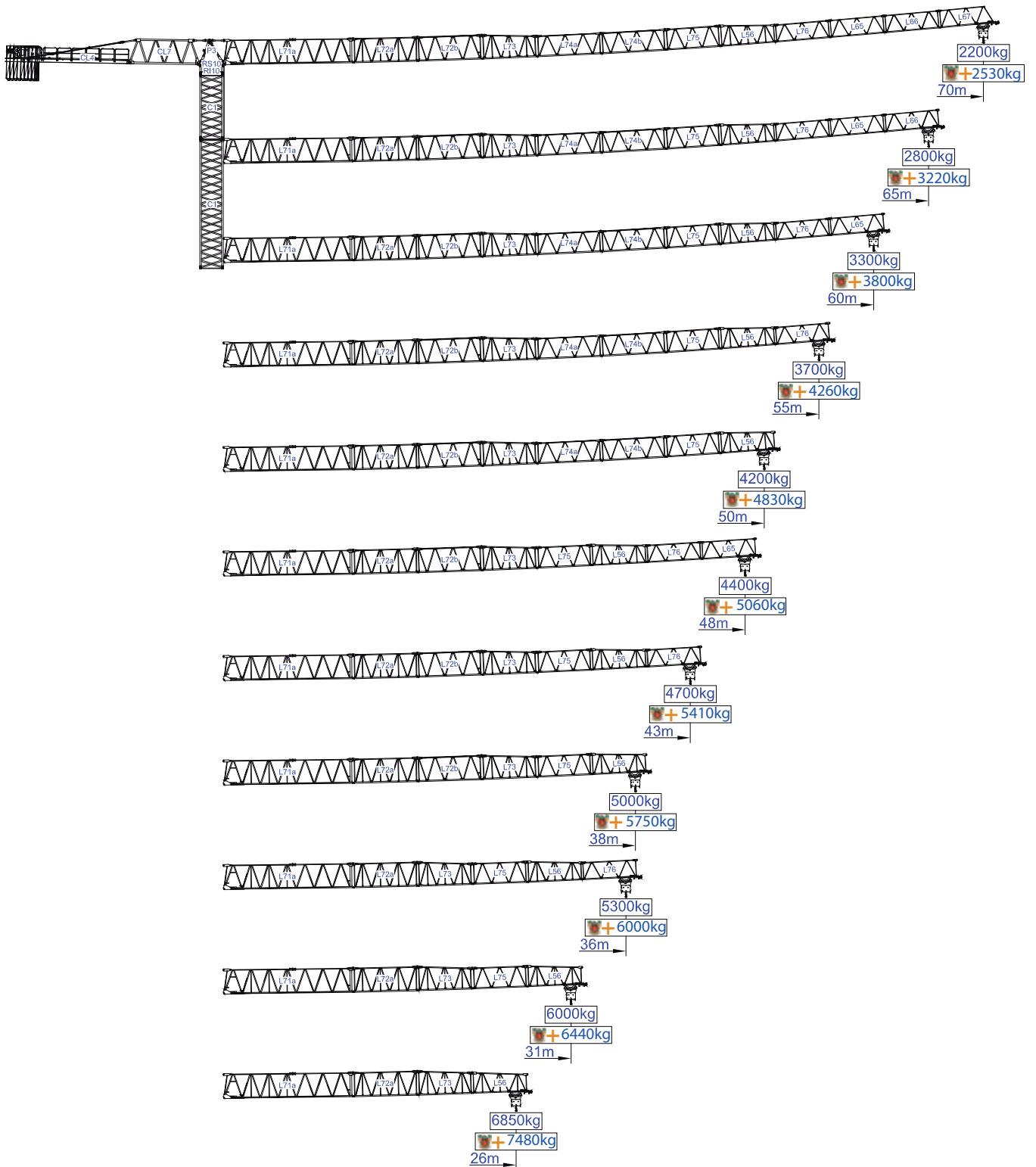

m	Diagram	Crane Config		Load Capacity (kg)																m	kg
		12000kg	6000kg	10	15	18	21	26	31	36	38	43	48	50	55	60	65	70			
70	18000kg 8x2000kg + 2x1000kg	14.70	29.10	6000	6000	6000	6000	6000	5600	4750	4470	3900	3440	3280	2940	2650	2410	2200	1800		
				12000	11700	9600	8100	6370	5200	4350	4070	3500	3040	2880	2540	2250	2010	1800			
65	18000kg 8x2000kg + 2x1000kg	16.60	33.00	6000	6000	6000	6000	6000	6000	5460	5140	4490	3970	3790	3400	3080	2800				
				12000	12000	11020	9310	7350	6020	5060	4740	4090	3570	3390	3000	2680	2400				
60	18000kg 8x2000kg + 2x1000kg	17.70	35.10	6000	6000	6000	6000	6000	6000	5830	5500	4800	4250	4060	3650	3300					
				12000	12000	11770	9960	7870	6450	5430	5100	4400	3850	3660	3250	2900					
55	17000kg 8x2000kg + 1x1000kg	17.90	35.50	6000	6000	6000	6000	6000	6000	5920	5580	4870	4310	4120	3700						
				12000	12000	11930	10100	7980	6550	5520	5180	4470	3910	3720	3300						
50	16000kg 7x2000kg + 2x1000kg	18.20	36.20	6000	6000	6000	6000	6000	6000	6000	5680	4970	4400	4200							
				12000	12000	12000	10290	8140	6680	5630	5280	4570	4000	3800							
48	15000kg 7x2000kg + 1x1000kg	18.20	36.20	6000	6000	6000	6000	6000	6000	6000	5690	4970	4400								
				12000	12000	12000	10300	8150	6690	5630	5290	4570	4000								
43	13000kg 6x2000kg + 1x1000kg	17.30	34.40	6000	6000	6000	6000	6000	6000	5710	5380	4700									
				12000	12000	11520	9750	7700	6310	5310	4980	4300									
38	11000kg 5x2000kg + 1x1000kg	16.20	32.20	6000	6000	6000	6000	6000	6000	5310	5000										
				12000	12000	10710	9050	7140	5840	4910	4600										
36	9000kg 4x2000kg + 1x1000kg	16.20	32.10	6000	6000	6000	6000	6000	6000	5300											
				12000	12000	10700	9040	7130	5840	4900											
31	8000kg 3x2000kg + 2x1000kg	15.60	31.00	6000	6000	6000	6000	6000	6000												
				12000	12000	10290	8700	6850	5600												
26	7000kg 3x2000kg + 1x1000kg	15.30	30.40	6000	6000	6000	6000	6000													
				12000	11930	9790	8260	6500													

SACS
15%







m	Diagram	Crane Config		Load Capacity (kg)																m	kg
		12000kg	6000kg	10	15	18	21	26	31	36	38	43	48	50	55	60	65	70			
70	18000kg 8x2000kg + 2x1000kg	14.70	29.10	6000	6000	6000	6000	6000	6000	5460	5140	4490	3960	3770	3380	3050	2770	2530	2070		
				12000	12000	11040	9320	7330	5980	5000	4680	4030	3500	3310	2920	2590	2310	2070			
65	18000kg 8x2000kg + 2x1000kg	16.60	33.00	6000	6000	6000	6000	6000	6000	6000	5910	5160	4570	4360	3910	3540	3220				
				12000	12000	12000	10710	8450	6920	5820	5450	4700	4110	3900	3450	3080	2760				
60	18000kg 8x2000kg + 2x1000kg	17.70	35.10	6000	6000	6000	6000	6000	6000	6000	6000	5520	4890	4670	4200	3800					
				12000	12000	12000	11450	9050	7420	6240	5870	5060	4430	4210	3740	3340					
55	17000kg 8x2000kg + 1x1000kg	17.90	35.50	6000	6000	6000	6000	6000	6000	6000	6000	5600	4960	4740	4260						
				12000	12000	12000	11620	9180	7530	6350	5960	5140	4500	4280	3800						
50	16000kg 7x2000kg + 2x1000kg	18.20	36.20	6000	6000	6000	6000	6000	6000	6000	6000	5720	5060	4830							
				12000	12000	12000	11830	9360	7680	6470	6070	5260	4600	4370							
48	15000kg 7x2000kg + 1x1000kg	18.20	36.20	6000	6000	6000	6000	6000	6000	6000	6000	5720	5060								
				12000	12000	12000	11850	9370	7690	6470	6080	5260	4600								
43	13000kg 6x2000kg + 1x1000kg	17.30	34.40	6000	6000	6000	6000	6000	6000	6000	6000	6190	5410								
				12000	12000	12000	11210	8860	7260	6110	5730	4950									
38	11000kg 5x2000kg + 1x1000kg	16.20	32.20	6000	6000	6000	6000	6000	6000	6110	5750										
				12000	12000	12320	10410	8210	6720	5650	5290										
36	9000kg 4x2000kg + 1x1000kg	16.20	32.10	6000	6000	6000	6000	6000	6000	6000	6000										
				12000	12000	12310	10400	8200	6720	5640											
31	8000kg 3x2000kg + 2x1000kg	15.60	31.00	6000	6000	6000	6000	6000	6000												
				12000	12000	11830	10010	7880	6440												
26	7000kg 3x2000kg + 1x1000kg	15.30	30.40	6000	6000	6000	6000	6000													
				12000	12000	11260	9500	7480													





			A (mm)	B (mm)	C (mm)	kg	
Jib / Lança / Fleche / Braccio		L71A	11970	1900	2900	6750	
/ Ausleger / кливер		L72A	6185	1160	2260	1400	
		L72B	6195	1160	2260	1140	
		L73	5230	1160	2260	780	
		L74A	6165	1160	1950	830	
		L74B	6165	1160	1950	710	
		L75	5200	1160	1950	560	
		L56	5200	1160	1930	530	
		L76	5160	1160	1610	400	
		L65	5110	1160	1610	360	
		L66	5110	1160	1610	300	
		L67	5110	1160	1610	300	
	Head turntable / Cabeçote / Pivot / Testa giradischi / Kopfplattenspieler		RS10 RI10	2620	2180	2150	8000
			P3	2430	1300	760	1270
	Counter-jib / Contra lança / Contre-fleche		CL7	6470	1240	2285	2600
		CL4	11400	1500	500	3750	
Counterweight / Contrapeso / Contrepoids / Gegengewicht / Противовес		CP2	1160	330	3140	8x2000 16000	
		CP3	1160	165	3140	2x1000 2000	
Tower section / torre / Coupe tour / Sezione torre / Turmabschnitt / Секция башни		C1	12000	2180	2180	4200	
		C1	6130	2180	2180	2200	
		C1	3195	2180	2180	1200	
Climbing tower section		C1	3195	2250	2250	1360	
Foundation anchor / Tramo encastrar /		C1	2280	2150	2150	850	
Base Chassis		C1	8127	800	1370	4600	
			4200	380	1370	2x1700 3400	
						TOTAL	8000
Base Chassis		C1s	6605	800	1370	3420	
			3160	380	1370	2x1840 3680	
						TOTAL	7100



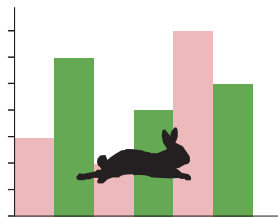

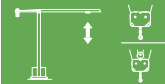

		
	0 a 1 r.p.m.	3x5 daN.m
	0 a 60 m/min	5,5 kW
	0-10 m/min	2x4 kW

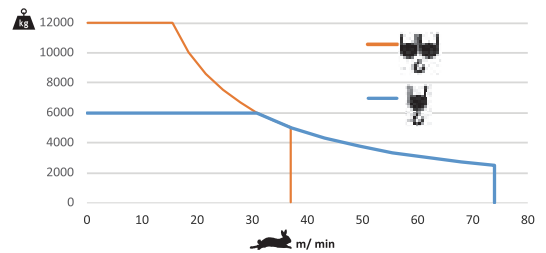



		
	0 a 74 m/min	37 kW
	0 a 37 m/min	



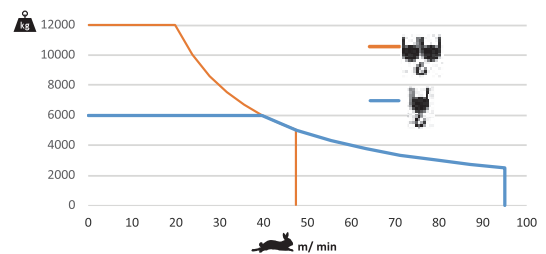

	55 kVA
	400 V +- 5% (50/60 Hz)

		
	0 a 95 m/min	45 kW
	0 a 47,5 m/min	



	65 kVA
	400 V +- 5% (50/60 Hz)

Max height of hoist

 (H)Max. 54m
 (H)Max. 108m +  More options



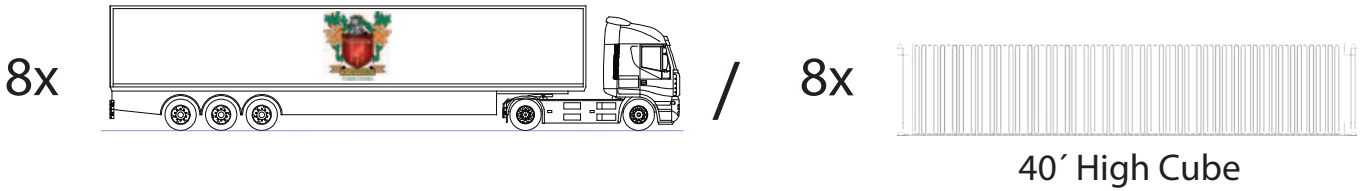
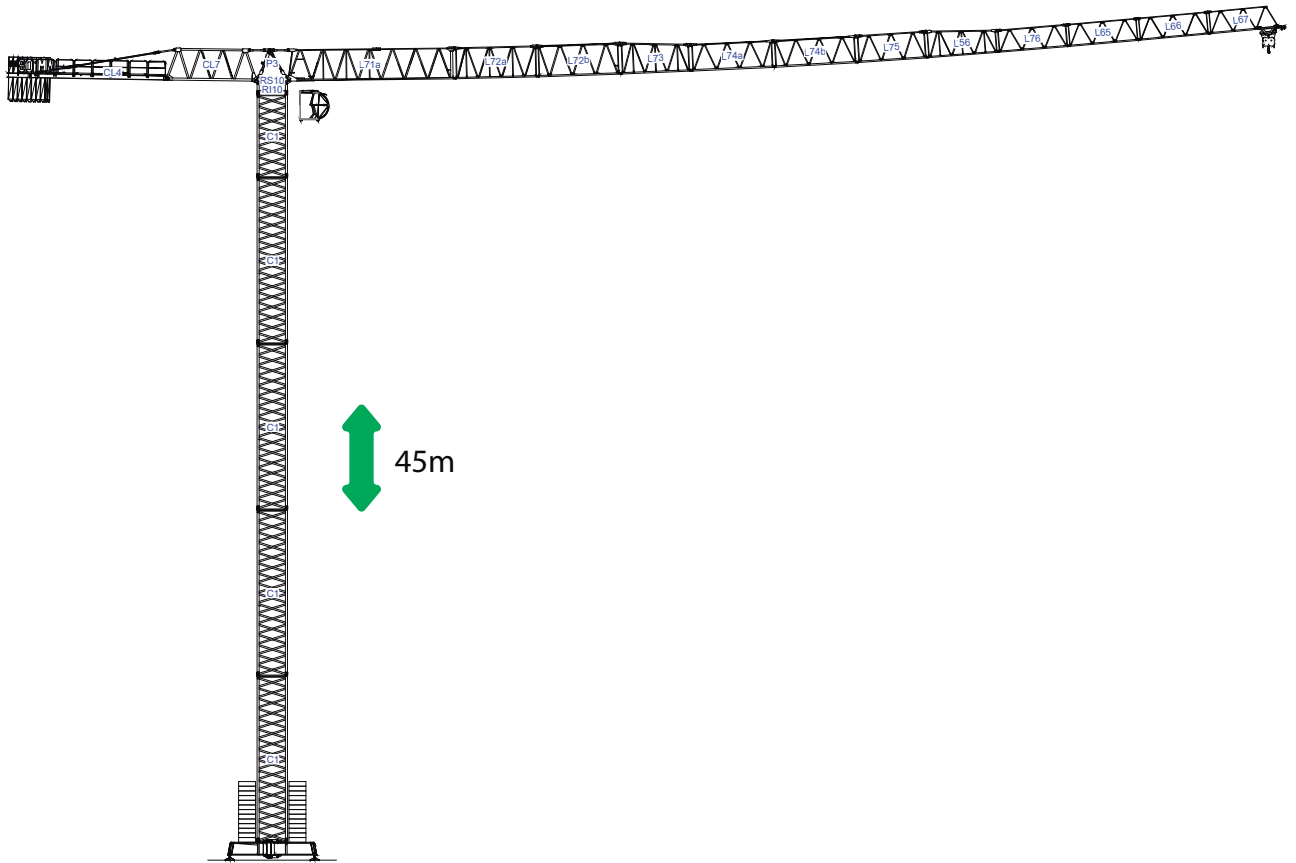

1

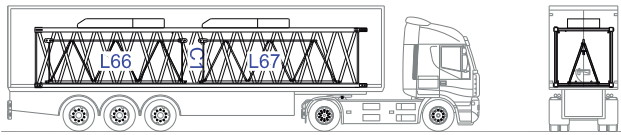

C1-L66-L67-2xCP2

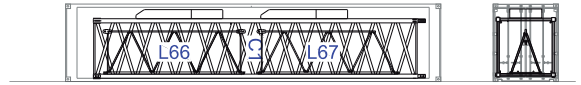

2

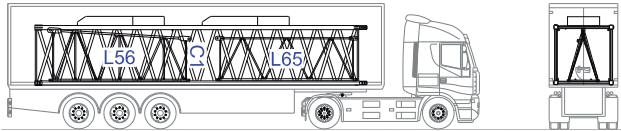

C1-L56-L65-2xCP2

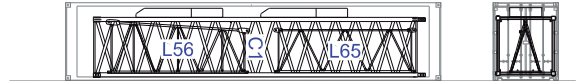

3

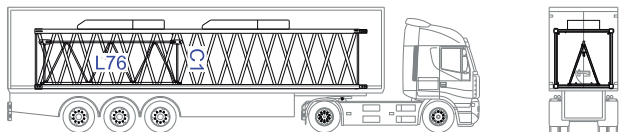

C1-L76-2xCP2

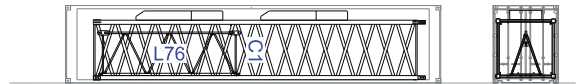

4

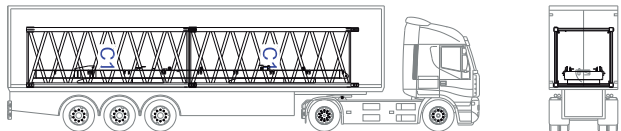

2xC1-CL4-2xCP3

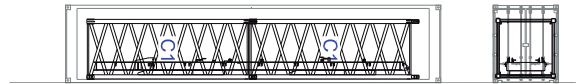
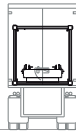

5

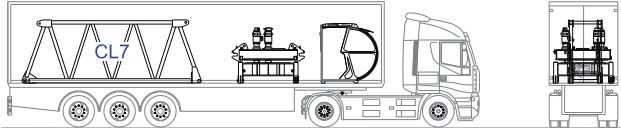

CL7-RI10-RS10-C1

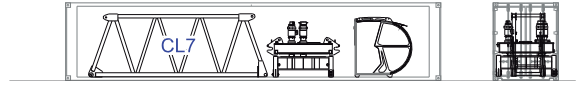
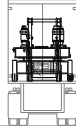

6

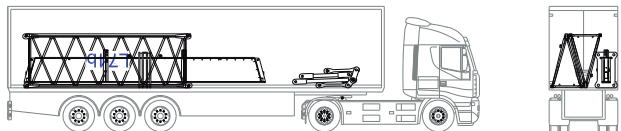

L42a-L42b-C1-P3

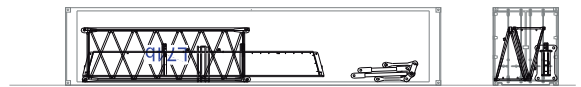

7

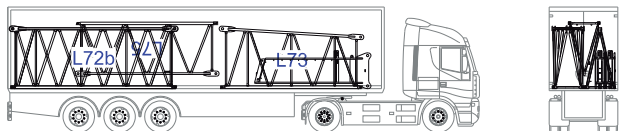

L72a-L72b-L73-L75-2xC1

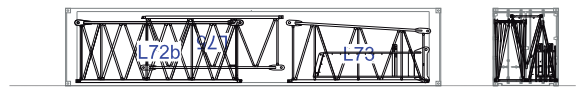

8

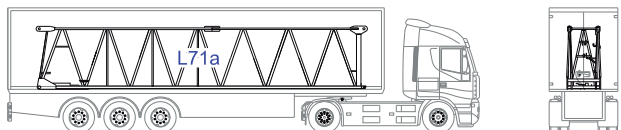

CL7-RI10-RS10-C1

